

Chapter 6

The Link Layer and LANs

A note on the use of these PowerPoint slides:

We're making these slides freely available to all (faculty, students, readers). They're in PowerPoint form so you see the animations; and can add, modify, and delete slides (including this one) and slide content to suit your needs. They obviously represent a *lot* of work on our part.

In return for use, we only ask the following:

- If you use these slides (e.g., in a class) that you mention their source (after all, we'd like people to use our book!)
- If you post any slides on a www site, that you note that they are adapted from (or perhaps identical to) our slides, and note our copyright of this material.

For a revision history, see the slide note for this page.

Thanks and enjoy! JFK/KWR

All material copyright 1996-2020
J.F Kurose and K.W. Ross, All Rights Reserved

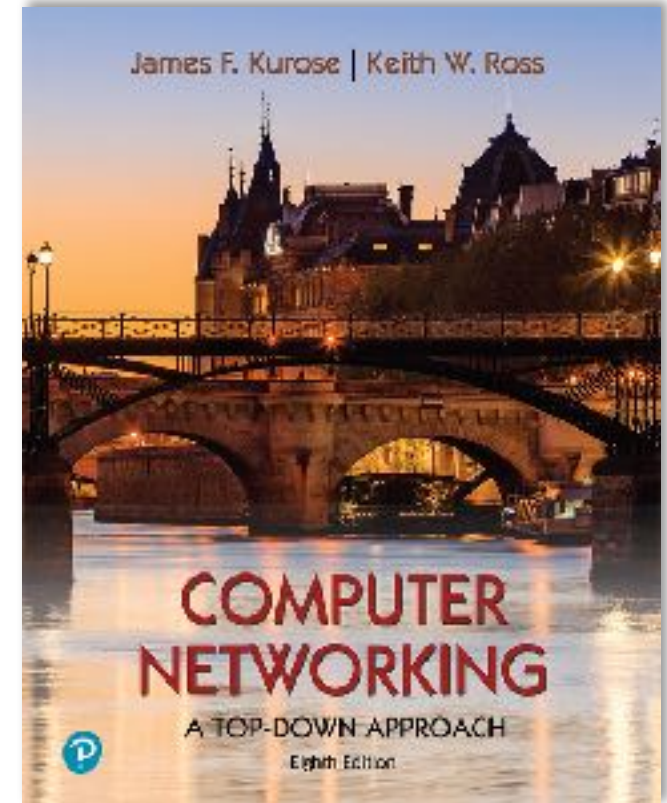

Computer Networking: A Top-Down Approach

8th edition

Jim Kurose, Keith Ross

Pearson, 2020

Link layer and LANs: our goals

- understand principles behind link layer services:
 - error detection, correction
 - sharing a broadcast channel: multiple access
 - link layer addressing
 - local area networks: Ethernet, VLANs
- datacenter networks
- instantiation, implementation of various link layer technologies



Link layer, LANs: roadmap

- **introduction**
- error detection, correction
- multiple access protocols
- LANs
 - addressing, ARP
 - Ethernet
 - switches
 - VLANs
- link virtualization: MPLS
- data center networking



- a day in the life of a web request

Link layer: introduction

terminology:

- hosts and routers: nodes
- communication channels that connect adjacent nodes along communication path: links
 - wired
 - wireless
 - LANs
- layer-2 packet: *frame*, encapsulates datagram

link layer has responsibility of transferring datagram from one node to *physically adjacent* node over a link

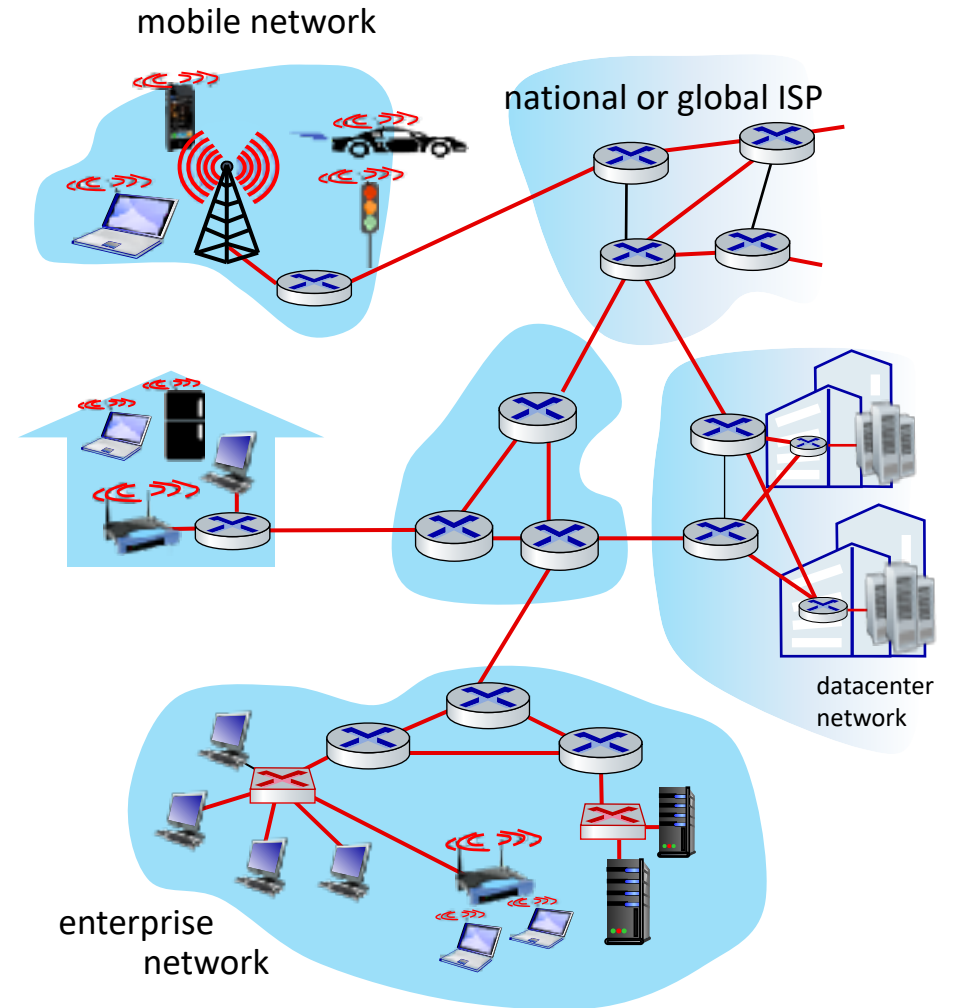

Link layer: context

- datagram transferred by different link protocols over different links:
 - e.g., WiFi on first link, Ethernet on next link
- each link protocol provides different services
 - e.g., may or may not provide reliable data transfer over link

transportation analogy:

- trip from Princeton to Lausanne
 - limo: Princeton to JFK
 - plane: JFK to Geneva
 - train: Geneva to Lausanne
- tourist = **datagram**
- transport segment = **communication link**
- transportation mode = **link-layer protocol**
- travel agent = **routing algorithm**

Link layer: services

- **framing, link access:**
 - encapsulate datagram into frame, adding header, trailer
 - channel access if shared medium
 - “MAC” addresses in frame headers identify source, destination (different from IP address!)
- **reliable delivery between adjacent nodes**
 - we already know how to do this!
 - seldom used on low bit-error links
 - wireless links: high error rates
 - Q: why both link-level and end-end reliability?

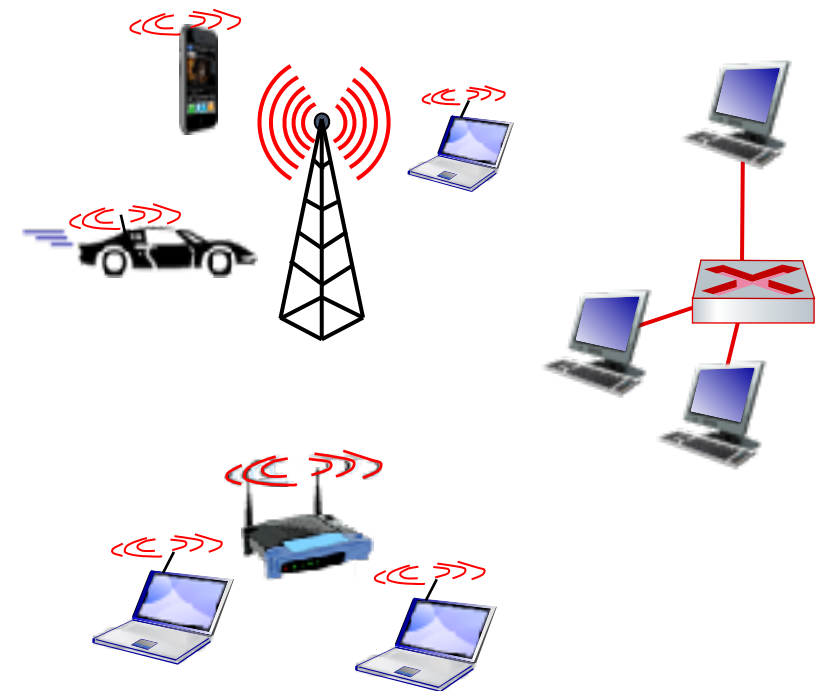
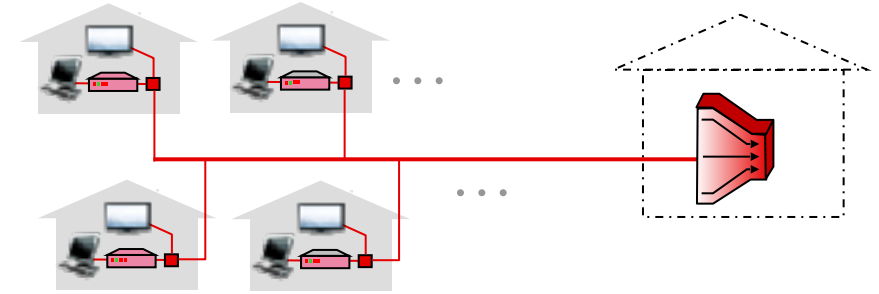

Link layer: services (more)

- **flow control:**
 - pacing between adjacent sending and receiving nodes
- **error detection:**
 - errors caused by signal attenuation, noise.
 - receiver detects errors, signals retransmission, or drops frame
- **error correction:**
 - receiver identifies *and corrects* bit error(s) without retransmission
- **half-duplex and full-duplex:**
 - with half duplex, nodes at both ends of link can transmit, but not at same time

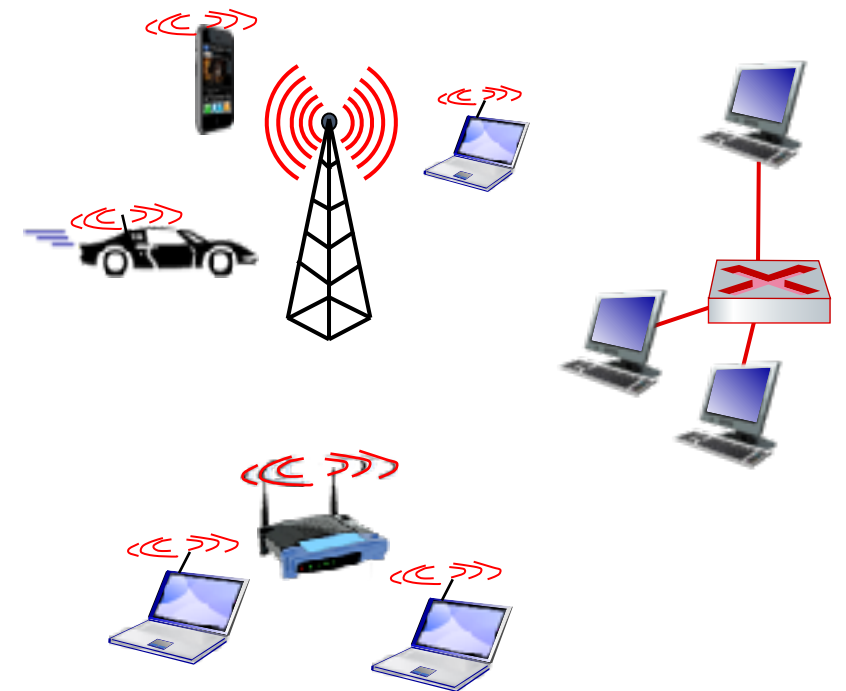
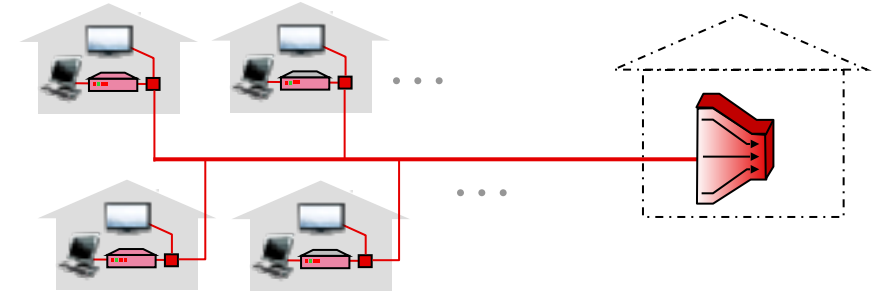

Where is the link layer implemented?

- in each-and-every host
- link layer implemented in *network interface card* (NIC) or on a chip
 - Ethernet, WiFi card or chip
 - implements link, physical layer
- attaches into host's system buses
- combination of hardware, software, firmware

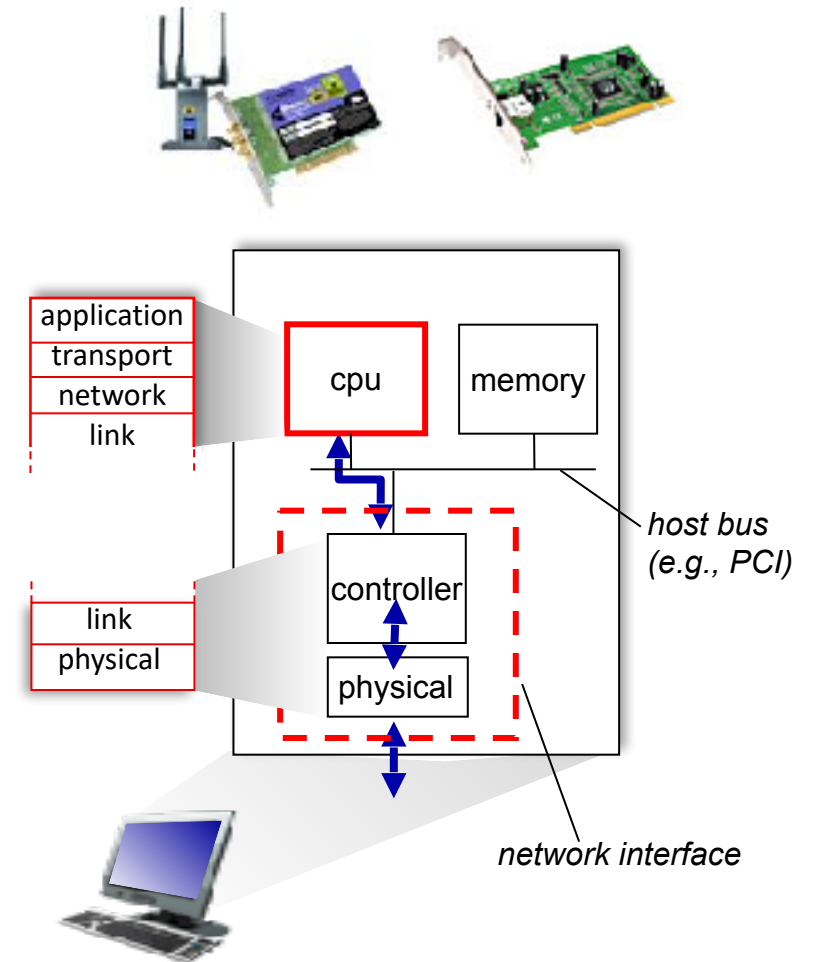

Interfaces communicating

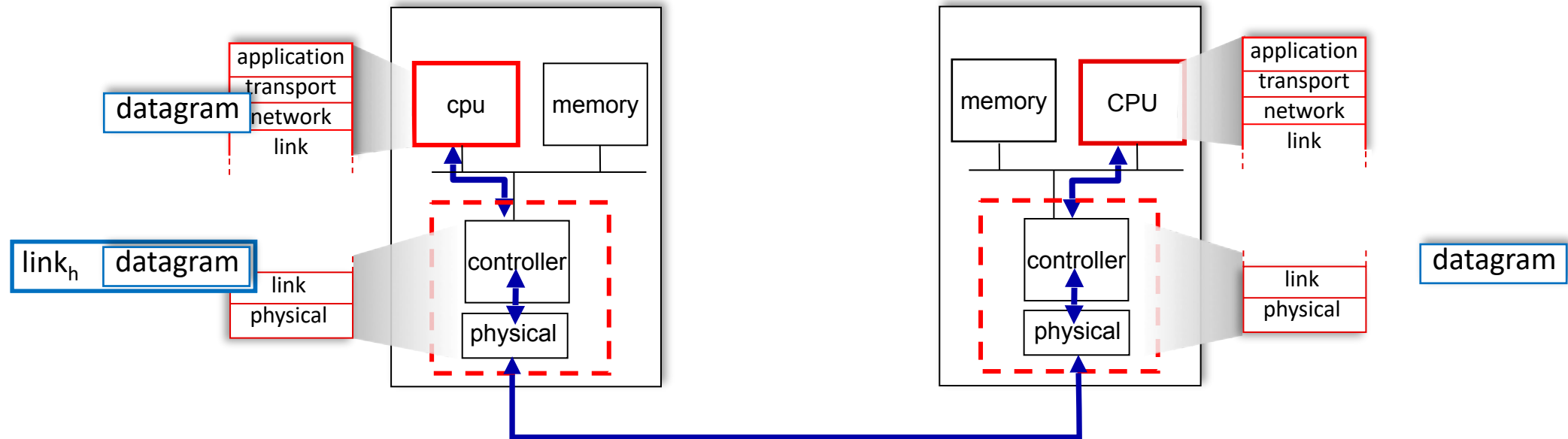

sending side:

- encapsulates datagram in frame
- adds error checking bits, reliable data transfer, flow control, etc.

receiving side:

- looks for errors, reliable data transfer, flow control, etc.
- extracts datagram, passes to upper layer at receiving side

Link layer, LANs: roadmap

- introduction
- **error detection, correction**
- multiple access protocols
- LANs
 - addressing, ARP
 - Ethernet
 - switches
 - VLANs
- link virtualization: MPLS
- data center networking



- a day in the life of a web request

Error detection

EDC: error detection and correction bits (e.g., redundancy)

D: data protected by error checking, may include header fields

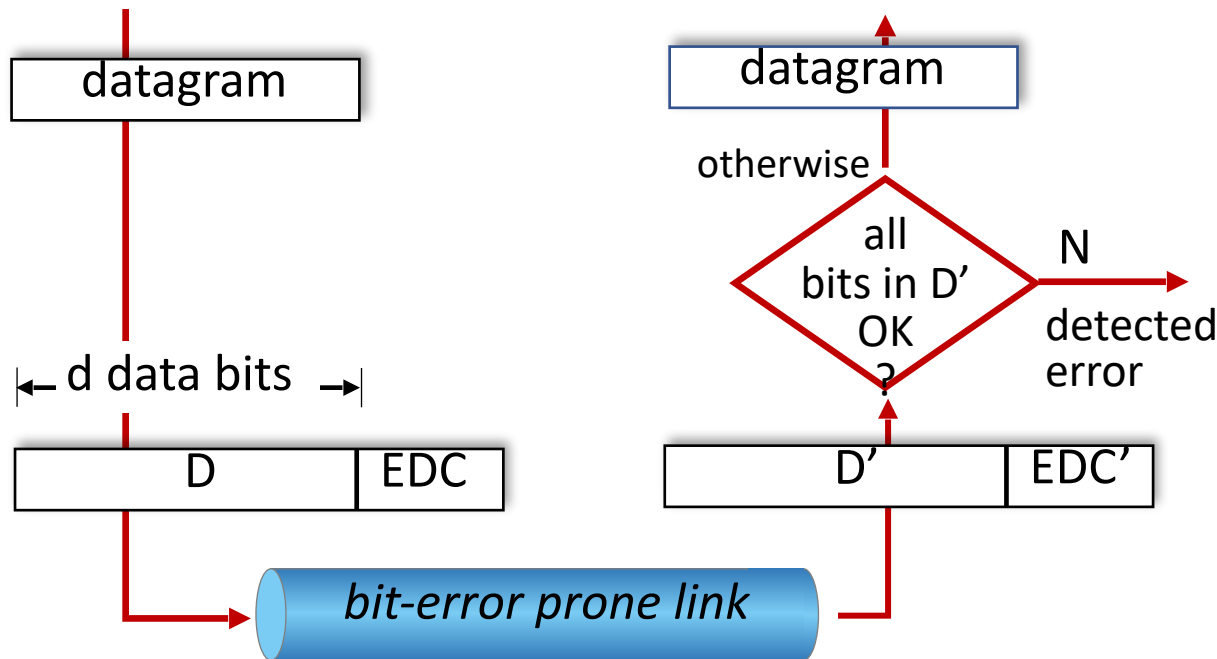

Error detection not 100% reliable!

- protocol may miss some errors, but rarely
- larger EDC field yields better detection and correction

Parity checking

single bit parity:

- detect single bit errors

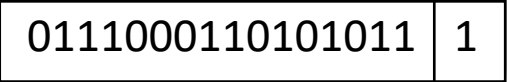

Even parity: set parity bit so there is an even number of 1's

two-dimensional bit parity:

- detect *and correct* single bit errors

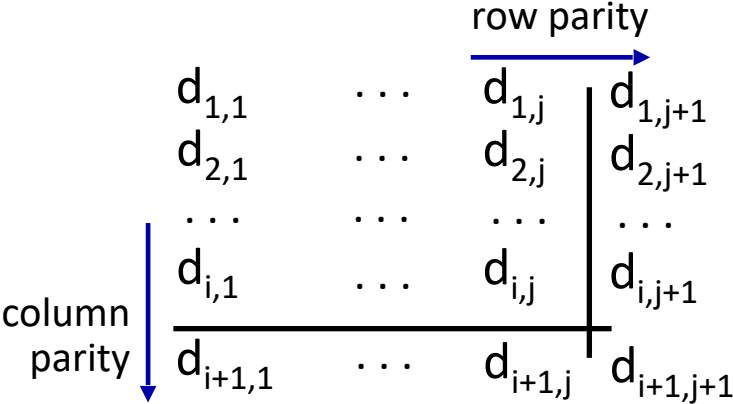

no errors:

1	0	1	0	1	1
1	1	1	1	0	0
0	1	1	1	0	1
1	0	1	0	1	0

detected and correctable single-bit error:

1	0	1	0	1	1
1	0	1	1	0	0
0	1	1	1	0	1
1	0	1	0	1	0

parity error (pointing to the 0 in row 2, column 2)

parity error (pointing to the 0 in row 2, column 2)

* Check out the online interactive exercises for more examples: http://gaia.cs.umass.edu/kurose_ross/interactive/

Internet checksum (review)

Goal: detect errors (*i.e.*, flipped bits) in transmitted segment

sender:

- treat contents of UDP segment (including UDP header fields and IP addresses) as sequence of 16-bit integers
- **checksum:** addition (one's complement sum) of segment content
- checksum value put into UDP checksum field

receiver:

- compute checksum of received segment
- check if computed checksum equals checksum field value:
 - not equal - error detected
 - equal - no error detected. *But maybe errors nonetheless?* More later

Cyclic Redundancy Check (CRC)

- more powerful error-detection coding
- **D**: data bits (given, think of these as a binary number)
- **G**: bit pattern (generator), of $r+1$ bits (given)

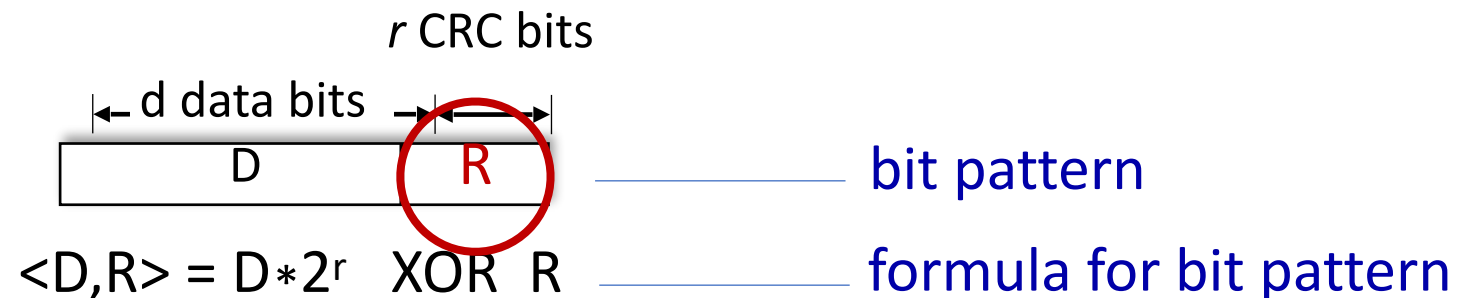

goal: choose r CRC bits, **R**, such that $\langle D, R \rangle$ exactly divisible by $G \pmod{2}$

- receiver knows G , divides $\langle D, R \rangle$ by G . If non-zero remainder: error detected!
- can detect all burst errors less than $r+1$ bits
- widely used in practice (Ethernet, 802.11 WiFi)

Cyclic Redundancy Check (CRC): example

We want:

$$D \cdot 2^r \text{ XOR } R = nG$$

or equivalently:

$$D \cdot 2^r = nG \text{ XOR } R$$

or equivalently:

if we divide $D \cdot 2^r$ by G , want remainder R to satisfy:

$$R = \text{remainder} \left[\frac{D \cdot 2^r}{G} \right]$$

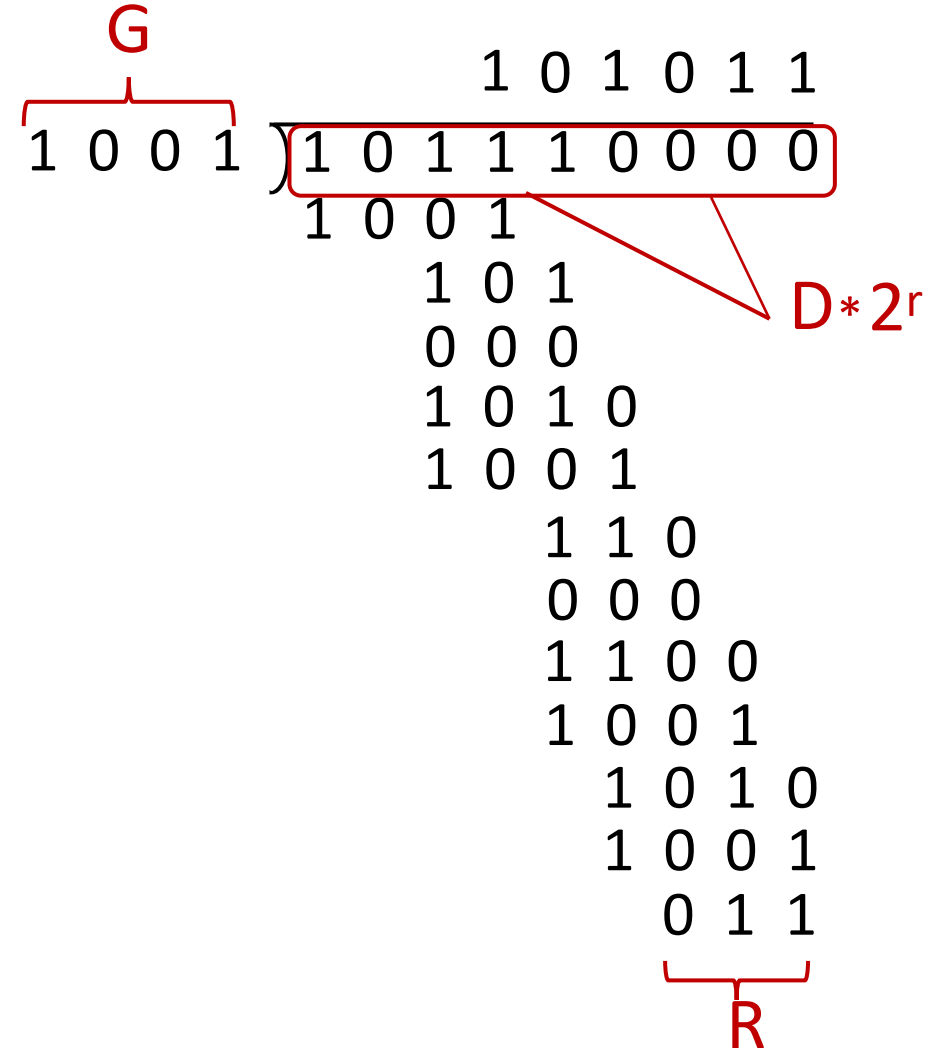

* Check out the online interactive exercises for more examples: http://gaia.cs.umass.edu/kurose_ross/interactive/

Link layer, LANs: roadmap

- introduction
- error detection, correction
- **multiple access protocols**
- LANs
 - addressing, ARP
 - Ethernet
 - switches
 - VLANs
- link virtualization: MPLS
- data center networking



- a day in the life of a web request

Multiple access links, protocols

two types of “links”:

- point-to-point
 - point-to-point link between Ethernet switch, host
 - PPP for dial-up access
- broadcast (shared wire or medium)
 - old-fashioned Ethernet
 - upstream HFC in cable-based access network
 - 802.11 wireless LAN, 4G/4G. satellite

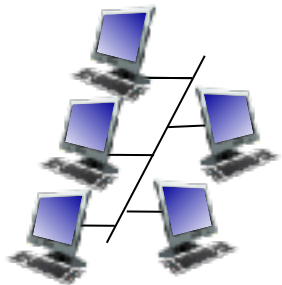

shared wire (e.g.,
cabled Ethernet)



shared radio: 4G/5G



shared radio: WiFi

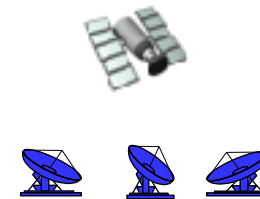

shared radio: satellite



humans at a cocktail party
(shared air, acoustical)

Multiple access protocols

- single shared broadcast channel
- two or more simultaneous transmissions by nodes: interference
 - *collision* if node receives two or more signals at the same time

multiple access protocol

- distributed algorithm that determines how nodes share channel, i.e., determine when node can transmit
- communication about channel sharing must use channel itself!
 - no out-of-band channel for coordination

An ideal multiple access protocol

given: multiple access channel (MAC) of rate R bps

desiderata:

1. when one node wants to transmit, it can send at rate R .
2. when M nodes want to transmit, each can send at average rate R/M
3. fully decentralized:
 - no special node to coordinate transmissions
 - no synchronization of clocks, slots
4. simple

MAC protocols: taxonomy

three broad classes:

- **channel partitioning**

- divide channel into smaller “pieces” (time slots, frequency, code)
- allocate piece to node for exclusive use

- ***random access***

- channel not divided, allow collisions
- “recover” from collisions

- **“taking turns”**

- nodes take turns, but nodes with more to send can take longer turns

Channel partitioning MAC protocols: TDMA

TDMA: time division multiple access

- access to channel in “rounds”
- each station gets fixed length slot (length = packet transmission time) in each round
- unused slots go idle
- example: 6-station LAN, 1,3,4 have packets to send, slots 2,5,6 idle

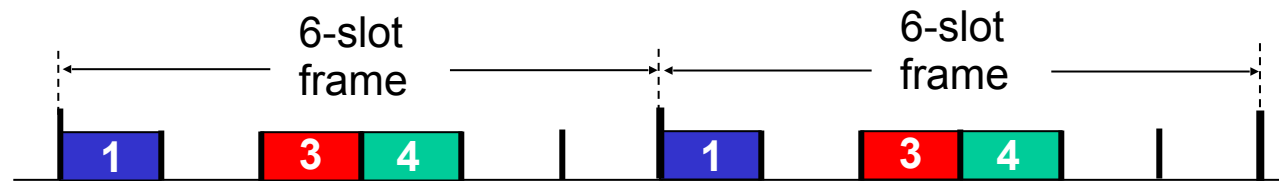

Channel partitioning MAC protocols: FDMA

FDMA: frequency division multiple access

- channel spectrum divided into frequency bands
- each station assigned fixed frequency band
- unused transmission time in frequency bands go idle
- example: 6-station LAN, 1,3,4 have packet to send, frequency bands 2,5,6 idle

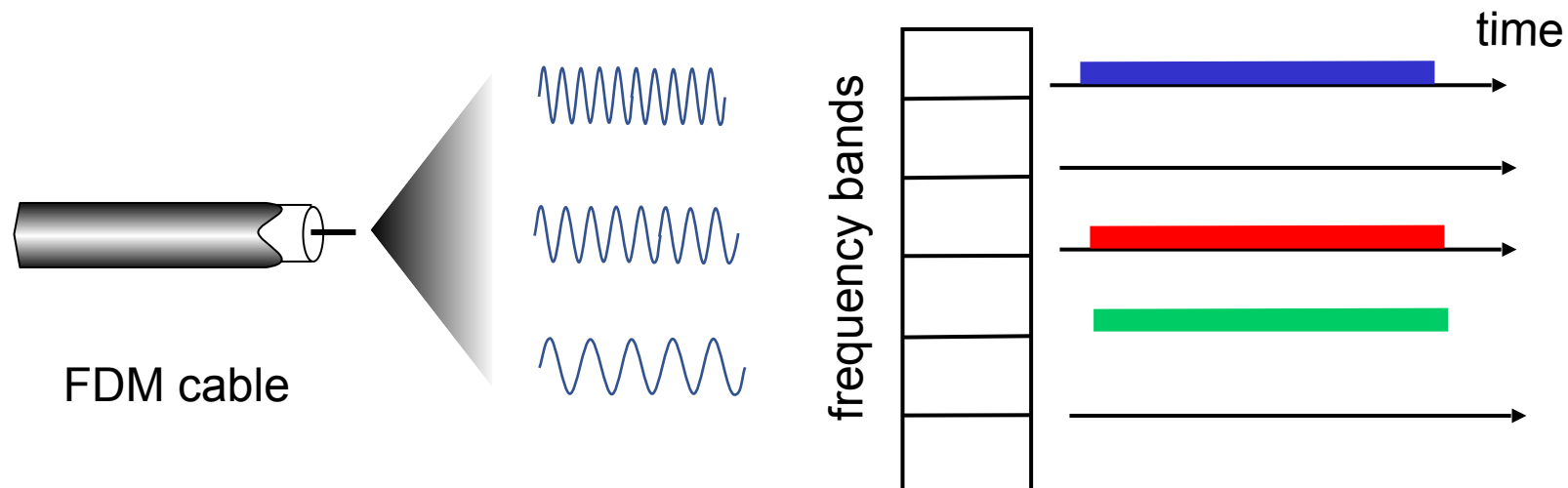

Random access protocols

- when node has packet to send
 - transmit at full channel data rate R .
 - no *a priori* coordination among nodes
- two or more transmitting nodes: “collision”
- **random access MAC protocol** specifies:
 - how to detect collisions
 - how to recover from collisions (e.g., via delayed retransmissions)
- examples of random access MAC protocols:
 - ALOHA, slotted ALOHA
 - CSMA, CSMA/CD, CSMA/CA

Slotted ALOHA

assumptions:

- all frames same size
- time divided into equal size slots (time to transmit 1 frame)
- nodes start to transmit only slot beginning
- nodes are synchronized
- if 2 or more nodes transmit in slot, all nodes detect collision

operation:

- when node obtains fresh frame, transmits in next slot
 - *if no collision*: node can send new frame in next slot
 - *if collision*: node retransmits frame in each subsequent slot with probability p until success

randomization – why?

Slotted ALOHA

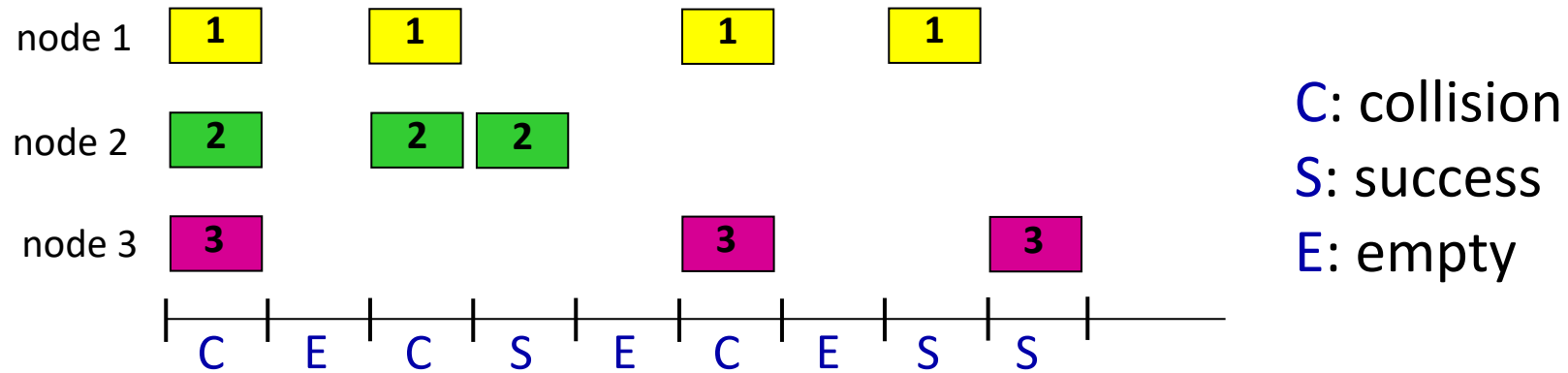

Pros:

- single active node can continuously transmit at full rate of channel
- highly decentralized: only slots in nodes need to be in sync
- simple

Cons:

- collisions, wasting slots
- idle slots
- nodes may be able to detect collision in less than time to transmit packet
- clock synchronization

Slotted ALOHA: efficiency

efficiency: long-run fraction of successful slots (many nodes, all with many frames to send)

- *suppose:* N nodes with many frames to send, each transmits in slot with probability p
 - prob that given node has success in a slot = $p(1-p)^{N-1}$
 - prob that *any* node has a success = $Np(1-p)^{N-1}$
 - max efficiency: find p^* that maximizes $Np(1-p)^{N-1}$
 - for many nodes, take limit of $Np^*(1-p^*)^{N-1}$ as N goes to infinity, gives:

max efficiency = $1/e = .37$

- ***at best:*** channel used for useful transmissions 37% of time!

Pure ALOHA

- unslotted Aloha: simpler, no synchronization
 - when frame first arrives: transmit immediately
- collision probability increases with no synchronization:
 - frame sent at t_0 collides with other frames sent in $[t_0-1, t_0+1]$

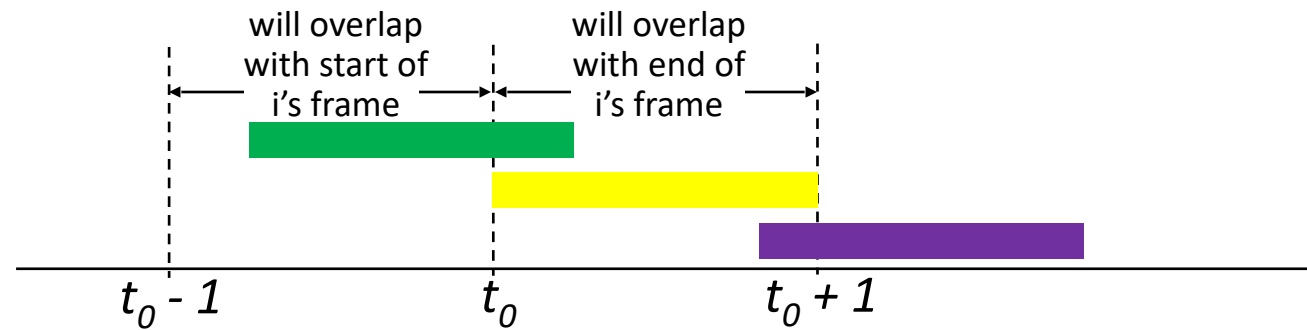

- pure Aloha efficiency: 18% !

CSMA (carrier sense multiple access)

simple **CSMA**: listen before transmit:

- if channel sensed **idle**: transmit entire frame
 - if channel sensed **busy**: defer transmission
- human analogy: don't interrupt others!

CSMA/CD: CSMA with *collision detection*

- collisions *detected* within short time
 - colliding transmissions aborted, reducing channel wastage
 - collision detection easy in wired, difficult with wireless
- human analogy: the polite conversationalist

CSMA: collisions

- collisions *can* still occur with carrier sensing:
 - propagation delay means two nodes may not hear each other's just-started transmission
- **collision**: entire packet transmission time wasted
 - distance & propagation delay play role in determining collision probability

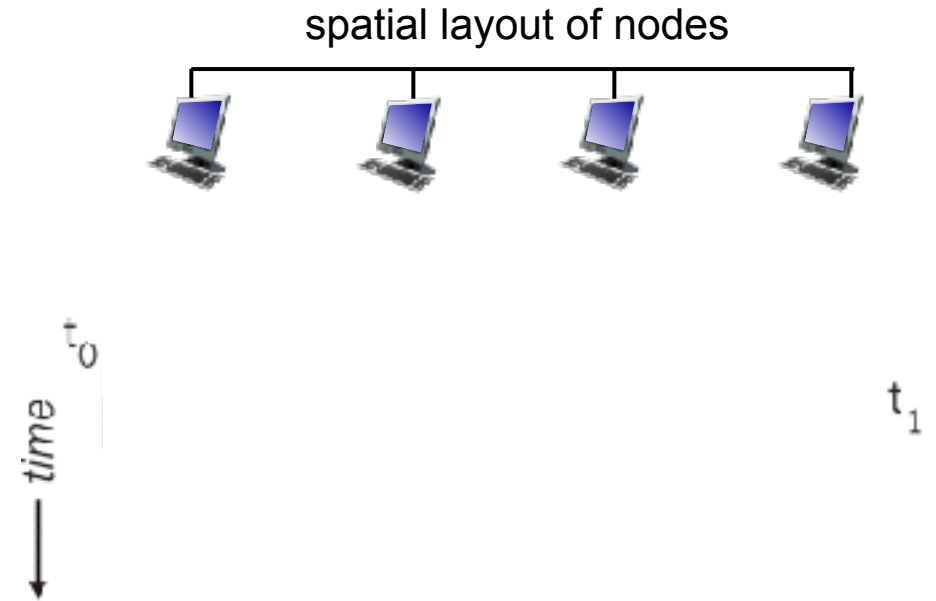

CSMA/CD:

- CSMA/CS reduces the amount of time wasted in collisions
 - transmission aborted on collision detection

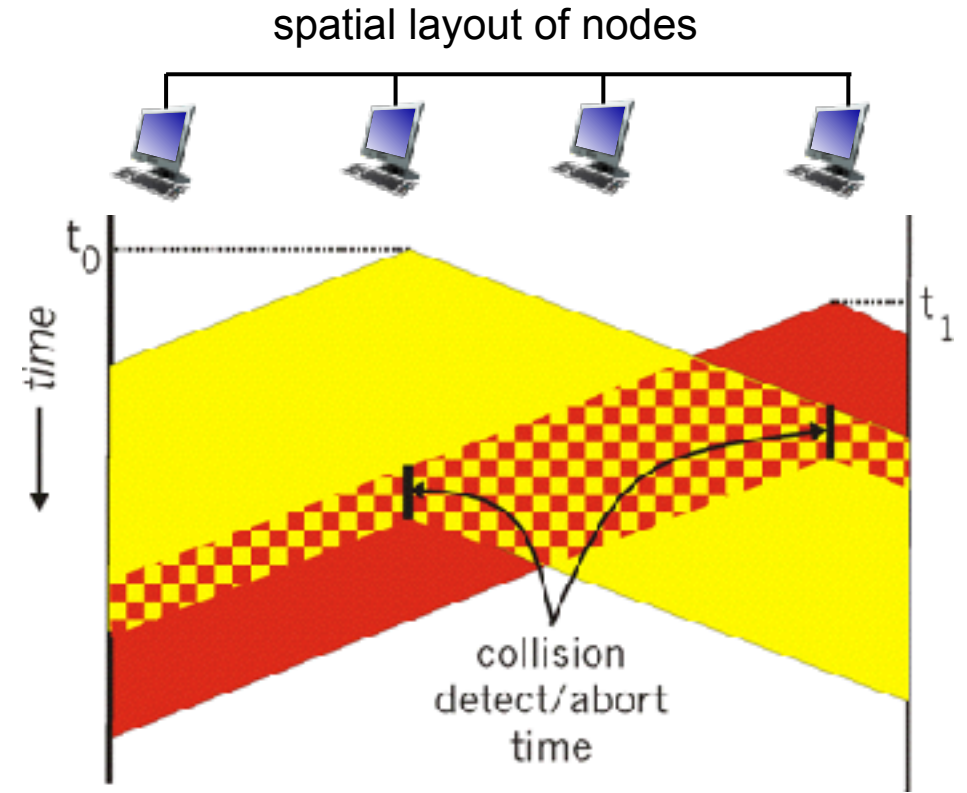

Ethernet CSMA/CD algorithm

1. NIC receives datagram from network layer, creates frame
2. If NIC senses channel:
 - if **idle**: start frame transmission.
 - if **busy**: wait until channel idle, then transmit
3. If NIC transmits entire frame without collision, NIC is done with frame !
4. If NIC detects another transmission while sending: abort, send jam signal
5. After aborting, NIC enters *binary (exponential) backoff*:
 - after m th collision, NIC chooses K at random from $\{0,1,2, \dots, 2^m-1\}$. NIC waits $K \cdot 512$ bit times, returns to Step 2
 - more collisions: longer backoff interval

CSMA/CD efficiency

- T_{prop} = max prop delay between 2 nodes in LAN
- t_{trans} = time to transmit max-size frame

$$efficiency = \frac{1}{1 + 5t_{prop}/t_{trans}}$$

- efficiency goes to 1
 - as t_{prop} goes to 0
 - as t_{trans} goes to infinity
- better performance than ALOHA: and simple, cheap, decentralized!

“Taking turns” MAC protocols

channel partitioning MAC protocols:

- share channel *efficiently* and *fairly* at high load
- inefficient at low load: delay in channel access, $1/N$ bandwidth allocated even if only 1 active node!

random access MAC protocols

- efficient at low load: single node can fully utilize channel
- high load: collision overhead

“taking turns” protocols

- look for best of both worlds!

“Taking turns” MAC protocols

polling:

- master node “invites” other nodes to transmit in turn
- typically used with “dumb” devices
- concerns:
 - polling overhead
 - latency
 - single point of failure (master)

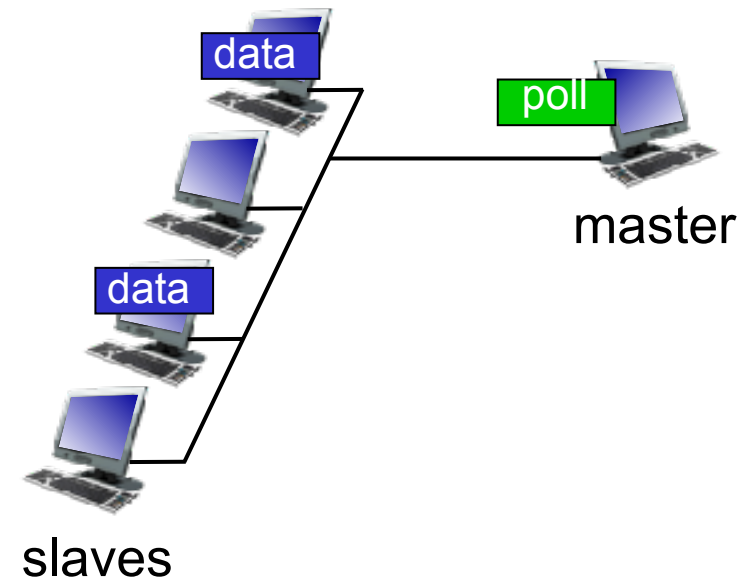

“Taking turns” MAC protocols

token passing:

- control *token* passed from one node to next sequentially.
- token message
- concerns:
 - token overhead
 - latency
 - single point of failure (token)

